



Wire-Free Smart Switch Installation Guide

Models

CWLSWDMBWF1

CWLSWCCBWF1

Simple DIY Set Up

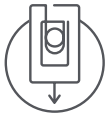

STEP 1

Install your Wire-Free Smart Switch



STEP 2

Download the Cync App, powered by Savant, on your smartphone



STEP 3

Add your Wire-Free Smart Switch to the Cync App

For set up help, visit gelighting.com/cync

GE and C by GE are trademarks of General Electric Company. Used under trademark license. Amazon, Alexa, and all related logos are trademarks of Amazon.com, Inc. or its affiliates. Google and other related marks and logos are trademarks of Google LLC.

Compatibility Requirements

Works with Cync and C by GE Smart Lights, Plugs, Switches, and Sensors. Not compatible with non-C by GE and non-Cync smart devices.

NOTE:

Wire-Free Smart Switch and other Cync Smart Lights, Plugs, and Switches must be grouped in the same Room/Space in the Cync App to enable full room control.

Let's Do It

INCLUDED

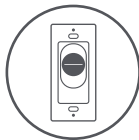

Switch



Wall Plate



4 Phillips
Mounting Screws



Drywall
Anchors



Adhesive Tape

YOU'LL NEED

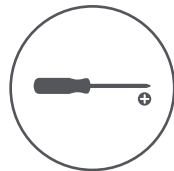

Phillips Screwdriver

OPTIONAL



Drill w/ 7/32 bit

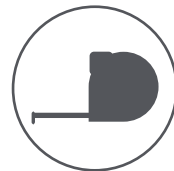

Tape Measure

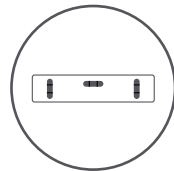

Level

You Got This!

And we're here to help.

For in-depth instructional videos and a guided tour through the installation, go to gelighting.com/cync.

BEFORE YOU DO ANYTHING!

Location & Mounting Type

Decide how you want to mount your switch.

This switch can be mounted to the wall in two ways, by screws or adhesive tape.

Once you determine which install method is best for you, select one of the following setup methods.

Installing Your Smart Switch

Mounting with adhesive tape

IMPORTANT: Start by removing the clear plastic tab from the back of the Smart Switch.

STEP 1

Identify where you want to mount your Wire-Free Smart Switch (switches are typically located 48-52" from the floor to the top of the switch).

STEP 2

Prior to installation, be sure that the surface is smooth and degreased.

STEP 3

Apply adhesive tape to the middle back of the Smart Switch. Adhesive tab should stick out from the side of the switch. This will be covered by the wall plate and allows removal if needed in the future.

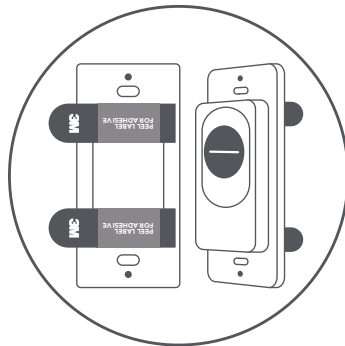

STEP 4

Mount Wire-Free Smart Switch to the wall.

STEP 5

Screw on the faceplate bracket, then snap the faceplate cover onto the bracket.

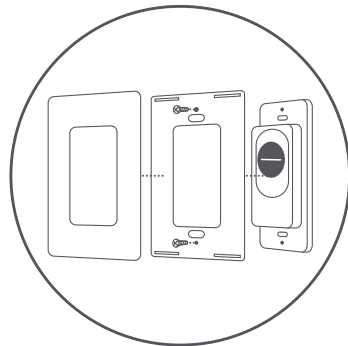

Installing Your Smart Switch

Mounting with screws/single-gang wall plate

IMPORTANT: Start by removing the clear plastic tab from the back of the Smart Switch.

STEP 1

Identify where you want to mount your Wire-Free Smart Switch (switches are typically located 48-52" from the floor to the top of the switch).

STEP 2

Mark the location for holes to be drilled. We suggest using the mounting holes on the switch housing as a guide. Use the level (optional) to ensure the switch is level before drilling holes.

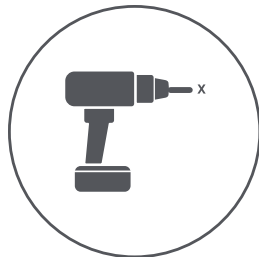
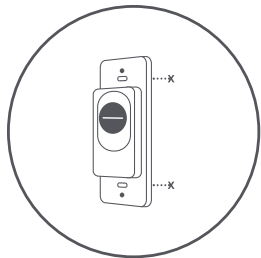

STEP 3

Using 7/32" bit, drill holes in wall for mounting screws. Insert drywall anchors.

STEP 4

Secure the Wire-Free Smart Switch to the wall until level and flush.

STEP 5

Screw on the faceplate bracket, then snap the faceplate cover onto the bracket.

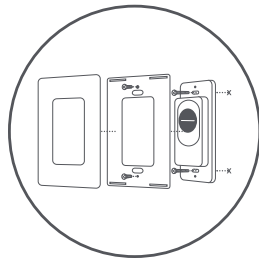

Installing Your Smart Switch

Mounting with screws/2-gang wall plate

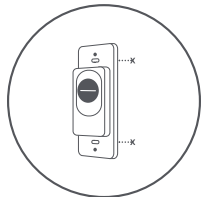

IMPORTANT: Start by removing the clear plastic tab from the back of the Smart Switch.

STEP 1

Remove existing wall plate.

STEP 2

Get multi-gang wall plate (purchased separately).

STEP 3

Use new wall plate to mark the location for holes to be drilled.

STEP 4

Using 7/32" bit, drill holes in wall for mounting screws. Insert drywall anchors.

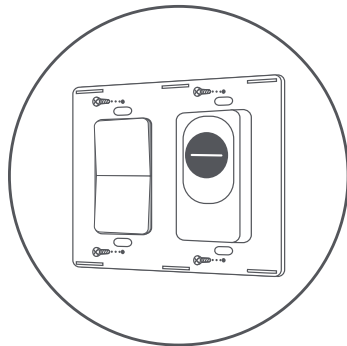
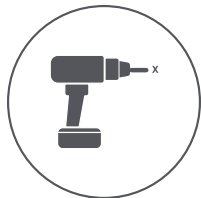

STEP 5

Secure the Wire-Free Smart Switch to the wall until level and flush.

STEP 6

Screw on the faceplate cover onto the bracket.

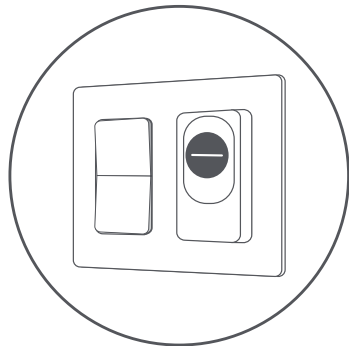

Simple Set Up Using the CYNC App

Unlock full features and connect to other CYNC devices



STEP 1

Download the Cync App, powered by Savant, on your smartphone.



STEP 2

Press any button on the Smart Switch to initiate set up. LED indicator light will flash blue until app set up is complete.



STEP 3

Add your Wire-Free Smart Switch to the Cync App.



STEP 4

Group your Wire-Free Smart Switch and other C by GE or Cync devices you want to control with the Smart Switch in the same Room/Space in the Cync App.

For set up help, visit gelighting.com/cync

What You Can Do With Your Wire-Free Smart Switch



Wire-Free Smart Switch + Smart Bulb

- Control lights without leaving your bed or couch
- Dim and brighten lights from the switch
- Keep switch control entering a room after moving furniture and plugging lamps into different sockets



Wire-Free Smart Switch + Smart Plug

- Control devices like fans and space heaters with the switch
- Add switch control to table and floor lamps with integrated LEDs or non-standard bulbs
- Keep switch control entering a room after moving furniture and plugging lamps into different sockets



Wire-Free Smart Switch + Wired Smart Switch

- Create 3-way connections without rewiring
- Control lights outside a room, like a kitchen light from the hallway
- Set up a master on/off switch next to your bed

Removing/Replacing the Battery

Uses one CR2032 coin battery

STEP 1

Remove the Wire-Free Smart Switch from the wall.

STEP 2

Remove rear housing of the switch using Phillips screwdriver.

STEP 3

Slide the battery out, toward the top of the switch.

STEP 4

Slide a new battery underneath the contact strap, with the (+) terminal toward the back of the switch.

STEP 5

Replace rear housing.

STEP 6

Secure the Wire-Free Smart Switch back onto the wall.

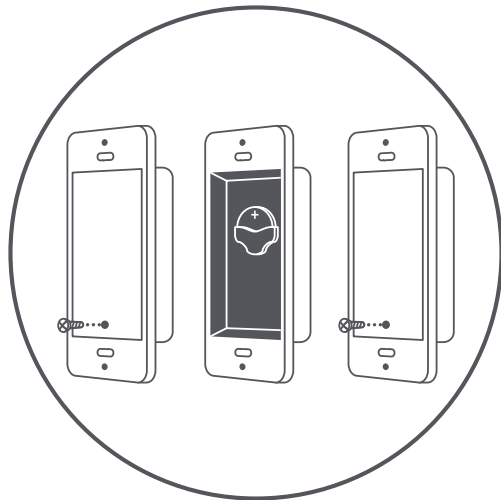

Additional Information and Warnings

FCC Compliance Statement Compliance Notice:

This equipment has been tested and found to comply with the limits for a Class B digital device, pursuant to part 15 of the FCC Rules. These limits are designed to provide reasonable protection against harmful interference in a residential installation. This equipment generates, uses and can radiate radio frequency energy and, if not installed and used in accordance with the instructions, may cause harmful interference to radio communications. However, there is no guarantee that interference will not occur in a particular installation. If this equipment does cause harmful interference to radio or television reception, which can be determined by turning the equipment off and on, the user is encouraged to try to correct the interference by one or more of the following measures:

- Reorient or relocate the receiving antenna.
- Increase the separation between the equipment and receiver.
- Connect the equipment into an outlet on a circuit different from that to which the receiver is connected.
- Consult the dealer or an experienced radio/TV technician for help.

FCC Radiation Exposure Statement

This device complies with FCC radiation exposure limits set forth for an uncontrolled environment. This equipment must be installed and operated in accordance with provided instructions to provide a separation distance of at least 20 cm from all persons.

This device complies with Part 15 of the FCC Rules. Operation is subject to the following two conditions:

- (1) this device may not cause harmful interference, and
- (2) this device must accept any interference received, including interference that may cause undesired operation.

⚠ CAUTION!

Any changes or modifications not expressly approved by the party responsible for compliance could void the user's authority to operate the equipment.

This device complies with Industry Canada's licence-exempt RSSs. Operation is subject to the following two conditions:

- (1) This device may not cause interference; and
- (2) This device must accept any interference, including interference that may cause undesired operation of the device.

Le présent appareil est conforme aux CNR d'industrie Canada applicables aux appareils radio exempts de licence. L'exploitation est autorisée aux deux conditions suivantes :

- (1) l'appareil ne doit pas produire de brouillage;
- (2) l'utilisateur de l'appareil doit accepter tout brouillage radioélectrique subi, même si le brouillage est susceptible d'en compromettre le fonctionnement.

The device meets the exemption from the routine evaluation limits in section 2.5 of RSS 102 and compliance with RSS-102 RF exposure, users can obtain Canadian information on RF exposure and compliance.

Le dispositif rencontre l'exemption des limites courantes d'évaluation dans la section 2.5 de RSS 102 et la conformité à l'exposition de RSS-102 rf, utilisateurs peut obtenir l'information canadienne sur l'exposition et la conformité de rf.

This transmitter must not be co-located or operating in conjunction with any other antenna or transmitter. This equipment should be installed and operated with a minimum distance of 20 centimeters between the radiator and your body.

Cet émetteur ne doit pas être Co-placé ou ne fonctionnant en même temps qu'aucune autre antenne ou émetteur. Cet équipement devrait être installé et actionné avec une distance minimum de 20 centimètres entre le radiateur et votre corps.

Additional Information and Warnings

Electric Ratings 3V

Operating temperature: 0 to 40°C

Type 1 Enclosure

Indoor use only

The Wire-Free Smart Switch uses one CR2032 battery (pre-installed). If installing the Wire-Free Smart Switch to an outlet box, follow National Electrical Code (NEC) (ANSI/NFPA 70), Canadian Electric Code, Part 1 (CEC), and local codes by a qualified technician.

⚠ WARNING: Chemical Burn Hazard. Keep batteries away from children. This product contains a lithium button/coin cell battery. If a new or used lithium button/coin cell battery is swallowed or enters the body, it can cause severe internal burns and can lead to death in as little as 2 hours. Always completely secure the battery compartment. If the battery compartment does not close securely, stop using the product, remove the batteries, and keep it away from children. If you think batteries might have been swallowed or placed inside any part of the body, seek immediate medical attention.

The cells shall be disposed of properly, including keeping them away from children, and even used cells may cause injury.

⚠ AVERTISSEMENT : Risque de brûlure chimique. Garder les piles hors de la portée des enfants. Ce produit contient une pile bouton au lithium. Si une pile bouton neuve ou usagée est avalée ou pénètre dans le corps, cela peut causer des brûlures internes graves et entraîner la mort en aussi peu que 2 heures. Fixer toujours solidement le compartiment de la pile. Si le compartiment de la pile ne se ferme pas solidement, cesser d'utiliser le produit, retirer la pile et la garder hors de la portée des enfants. S'il y a un risque pour qu'une pile ait été avalée ou placée à l'intérieur d'une partie du corps, consulter immédiatement un médecin.

Les piles doivent être éliminées de manière appropriée, y compris en les conservant hors de la portée des enfants; même les piles usagées peuvent causer des blessures.



**Like your new Wire-Free Smart Switch?
Share your experience!**

Leave a review where you purchased the product.

