

CSR Lamps

The GE CSR1200/SE/HR lamp is a metal halide lamp with an outer jacket and a small arc gap of 10 mm providing greater optical control and luminance. This lamp is compact and suitable for hot restrike applications. The CSR1200/SE/HR is mainly used in event lighting, studio, and film lighting.

Product Description CSR1200/SE/HR

•Order Description	CSR1200/SE/HR
•Product Code	48464
•Pack Quantity	6
•Rated Wattage	1,200W
•Rated Voltage	100±V
•Lamp Current (ECG/MCG)*	12.0A
•Ignition Voltage (cold/hot)	5/55(MAX)
•Lumens	110,000 Lm
•Lumens per watt	92
•Ra	>90
•Chromaticity coordinates	x 0.323 y 0.328
•Color temperature	6,000K
•Arc Length	10(MAX)mm
•Lamp length	MAX200
•Light center length	107±
•Lamp diameter	MAX42
•Average rated life	750hr
•Base	G38

*ECG = electronic control gear/ MCG = Magnetic control gear

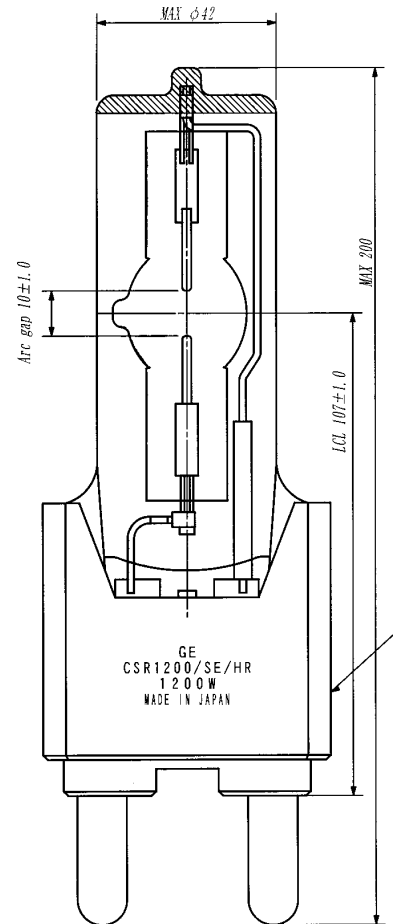

Lamp Operation

Burn Position Any
Maximum Seal Temperature 350° C
Cooling Forced Cooling/Fan
Lamp can be used on electronic or AC magnetic Ballast/igniters

Application Information

- Do not exceed rated wattage or voltage
- Replace lamp at or before rated life
- Do not exceed rated seal temperature
- Use only with properly rated fixtures and ballasts



GE imagination at work

and General Electric are both registered trademarks of the General Electric Company, USA. © General Electric Company (USA) 2006

GE Consumer & Industrial Specialty Lighting is constantly developing and improving its products. For this reason, all product descriptions in this brochure are intended as a general guide, and we may change specifications time to time in the interest of product development, without prior notification or public announcement. All descriptions in this publication present only general particulars of the goods to which they refer and shall not form part of any contract. Data in this guide has been obtained in controlled experimental conditions. However, GE Lighting cannot accept any liability arising from the reliance on such data to the extent permitted by law.

CSR1200/SE/HR - Data sheet - July 2006